



Lampes LED (Ampoules et projecteurs de remplacement)

Economie d'énergie

Longue durée de vie

Luminosité

Brillance

Atelier du Son et de l'Image

La Missou – D939 – Route d'Angoulême

24460 CHÂTEAU-L'ÉVÊQUE

Tel: +33(0)5 53 08 51 45 - Fax: +33(0)5 53 54 19 38

Mail: contact@adsi24.com – Site: www.adsi24.com



12V	MR16	GU5,3
AC DC	3x1W	INCLUS LED
38°	nicht graduabel	50mm Ø 50mm H

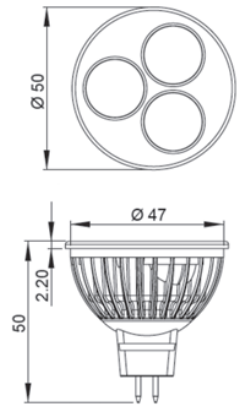

16,80 € HT

MR16 BC 38 B	Châssis blanc	Blanc chaud	3000K	38°	EEK: A
MR16 BC 38 A	Châssis argent	Blanc chaud	3000K	38°	EEK: A
MR16 BN 38 B	Châssis blanc	Blanc neutre	4000K	38°	EEK: A
MR16 BN 38 A	Châssis argent	Blanc neutre	4000K	38°	EEK: A
MR16 BF 38 B	Châssis blanc	Blanc froid	6000K	38°	EEK: A
MR16 BF 38 A	Châssis argent	Blanc froid	6000K	38°	EEK: A
MR16 BC 60 B	Châssis blanc	Blanc chaud	3000K	60°	EEK: A
MR16 BC 60 A	Châssis argent	Blanc chaud	3000K	60°	EEK: A

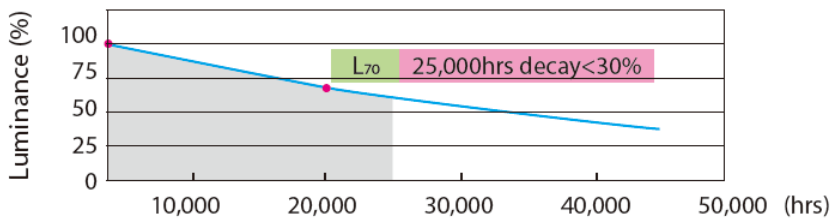
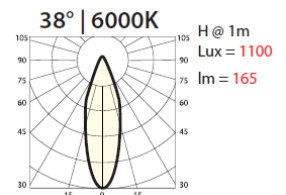
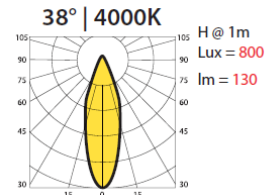
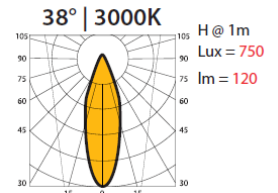
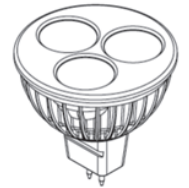

Niveaux énergétiques

La réglementation 98/11/EG impose la mention des classifications énergétiques pour les lampes à usage domestique. La classification énergétique comporte 7 niveaux - de A à G -, de très économe à moins économe sur le plan énergétique. Le niveau énergétique est défini par le rapport entre le flux lumineux en Lumens, et la puissance de la lampe en Watts.

Exemples de classement :

- Lampes fluocompactes et économie d'énergie : niveau A et B
- Lampes halogènes : niveau C et D majoritairement
- Lampes à filament : niveau E et F majoritairement

Dans le catalogue, les mentions de niveaux énergétiques sont indiqués sous la forme
EEK : "A-G"

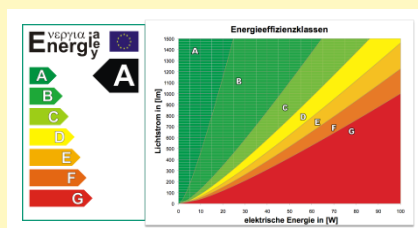



230V	GU10	3x1W
INCLUS LED	38°	nicht graduable
50mm Ø	55mm H	

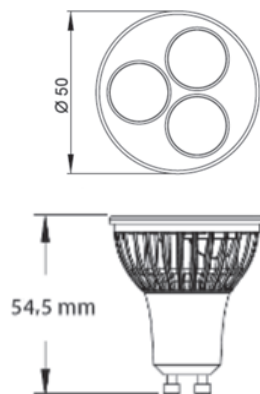

19.20 € HT

GU10 BC 38 B	Châssis blanc	Blanc chaud	3000K	38°	EEK: A
GU10 BC 38 A	Châssis argent	Blanc chaud	3000K	38°	EEK: A
GU10 BN 38 B	Châssis blanc	Blanc neutre	4000K	38°	EEK: A
GU10 BN 38 A	Châssis argent	Blanc neutre	4000K	38°	EEK: A
GU10 BF 38 B	Châssis blanc	Blanc froid	6000K	38°	EEK: A
GU10 BF 38 A	Châssis argent	Blanc froid	6000K	38°	EEK: A
GU10 BC 60 B	Châssis blanc	Blanc chaud	3000K	60°	EEK: A
GU10 BC 60 A	Châssis argent	Blanc chaud	3000K	60°	EEK: A

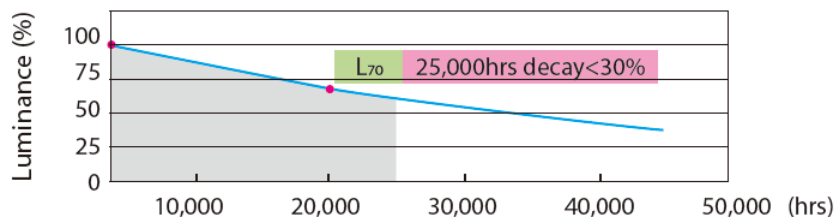
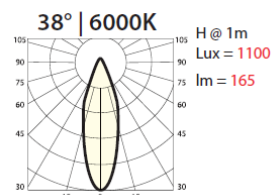
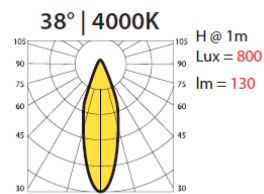
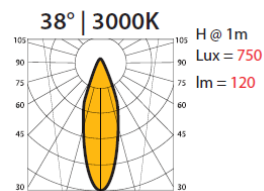



230V	E27	5W
INCLUS LED	nicht graduable	60mm Ø 110mm H

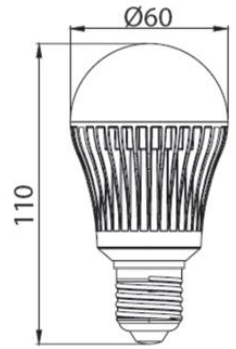

29,00 € HT

170241 Châssis argent Blanc chaud 3000K EEK: B
 170240 Châssis argent Blanc froid 6000K EEK: A

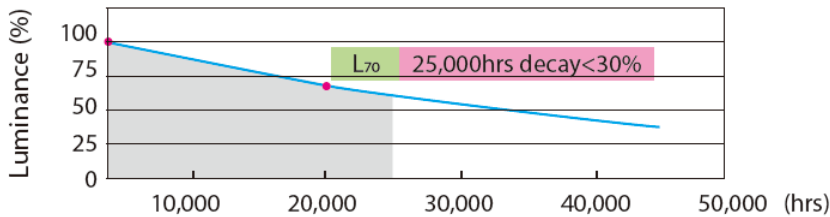
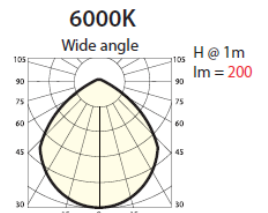
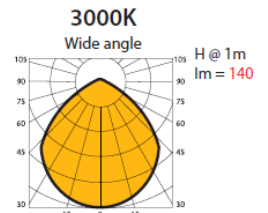

Niveaux énergétiques

La réglementation 98/11/EG impose la mention des classifications énergétiques pour les lampes à usage domestique. La classification énergétique comporte 7 niveaux - de A à G -, de très économe à moins économe sur le plan énergétique. Le niveau énergétique est défini par le rapport entre le flux lumineux en Lumens, et la puissance de la lampe en Watts.

Exemples de classement :

- Lampes fluocompactes et économie d'énergie : niveau A et B
- Lampes halogènes : niveau C et D majoritairement
- Lampes à filament : niveau E et F majoritairement

Dans le catalogue, les mentions de niveaux énergétiques sont indiqués sous la forme EEK : "A-G"

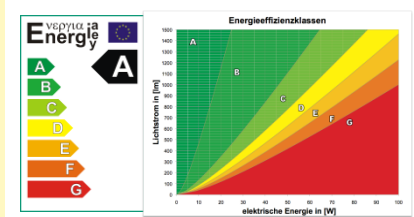



56,80 € HT

230V	E27	10W
INCLUS 6 LED	nicht graduable	95mm Ø 95mm H

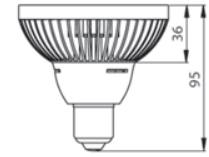
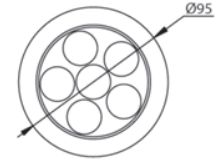

REF: LED PAR30 +

BC 25 N Châssis noir	Blanc chaud	3000K	25°	EEK: B
BC 25 B Châssis blanc	Blanc chaud	3000K	25°	EEK: B
BC 25 A Châssis argent	Blanc chaud	3000K	25°	EEK: B
BN 25 N Châssis noir	Blanc Neutre	4000K	25°	EEK: A
BN 25 B Châssis blanc	Blanc Neutre	4000K	25°	EEK: A
BN 25 A Châssis argent	Blanc Neutre	4000K	25°	EEK: A
BF 25 N Châssis noir	Blanc Froid	6000K	25°	EEK: A
BF 25 B Châssis blanc	Blanc Froid	6000K	25°	EEK: A
BF 25 A Châssis argent	Blanc Froid	6000K	25°	EEK: A
BC 40 N Châssis noir	Blanc chaud	3000K	40°	EEK: B
BC 40 B Châssis blanc	Blanc chaud	3000K	40°	EEK: B
BC 40 A Châssis argent	Blanc chaud	3000K	40°	EEK: B
BN 40 N Châssis noir	Neutral White	4000K	40°	EEK: A
BN 40 B Châssis blanc	Neutral White	4000K	40°	EEK: A
BN 40 A Châssis argent	Neutral White	4000K	40°	EEK: A
BF 40 N Châssis noir	Blanc Froid	6000K	40°	EEK: A
BF 40 B Châssis blanc	Blanc Froid	6000K	40°	EEK: A
BF 40 A Châssis argent	Blanc Froid	6000K	40°	EEK: A

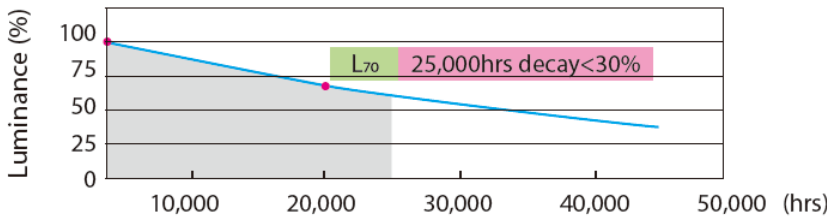
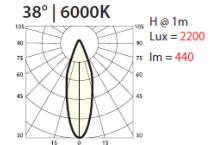
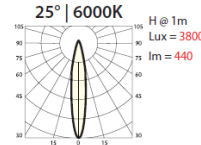
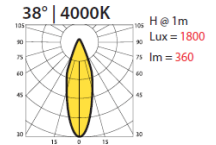
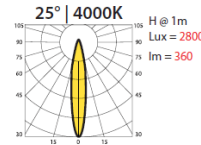
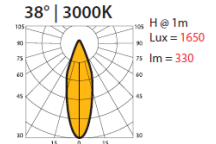
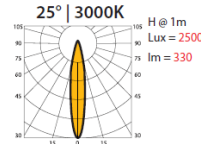



12V	G5,3	10W
AC DC	INCLUS 6 LED	nicht graduable
111mm	Ø	H
69mm		



62,40 € HT

REF: LED PAR36 +

BC 25 N Châssis noir	Blanc chaud 3000K	25°	EEK: B
BC 25 B Châssis blanc	Blanc chaud 3000K	25°	EEK: B
BC 25 A Châssis argent	Blanc chaud 3000K	25°	EEK: B
BN 25 N Châssis noir	Blanc Neutre 4000K	25°	EEK: A
BN 25 B Châssis blanc	Blanc Neutre 4000K	25°	EEK: A
BN 25 A Châssis argent	Blanc Neutre 4000K	25°	EEK: A
BF 25 N Châssis noir	Blanc Froid 6000K	25°	EEK: A
BF 25 B Châssis blanc	Blanc Froid 6000K	25°	EEK: A
BF 25 A Châssis argent	Blanc Froid 6000K	25°	EEK: A
BC 40 N Châssis noir	Blanc chaud 3000K	40°	EEK: B
BC 40 B Châssis blanc	Blanc chaud 3000K	40°	EEK: B
BC 40 A Châssis argent	Blanc chaud 3000K	40°	EEK: B
BN 40 N Châssis noir	Neutral White 4000K	40°	EEK: A
BN 40 B Châssis blanc	Neutral White 4000K	40°	EEK: A
BN 40 A Châssis argent	Neutral White 4000K	40°	EEK: A
BF 40 N Châssis noir	Blanc Froid 6000K	40°	EEK: A
BF 40 B Châssis blanc	Blanc Froid 6000K	40°	EEK: A
BF 40 A Châssis argent	Blanc Froid 6000K	40°	EEK: A

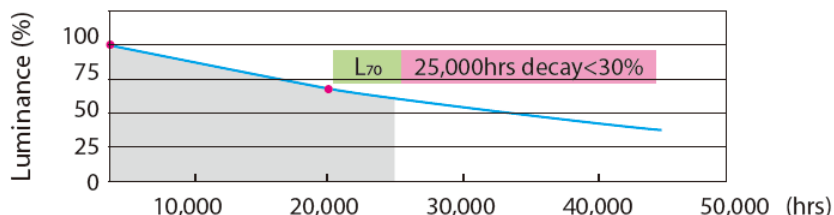
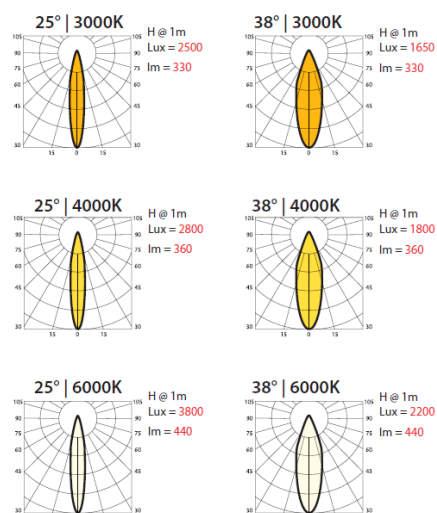



65,60 € HT

230V	GU10	10W
INCLUS 6 LED	nicht graduabel	111mm 69mm Ø H

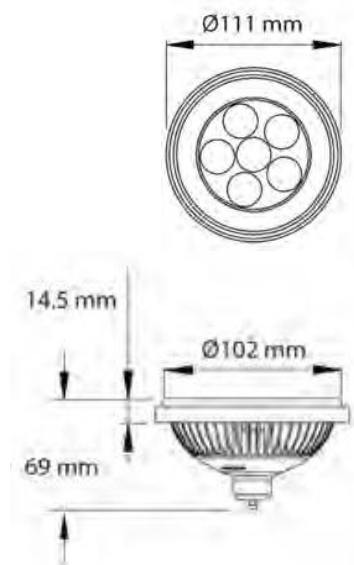

REF: LED PAR36220 + ...

BC 40 N Châssis noir	Blanc chaud	3000K	40°	EEK: B
BC 40 B Châssis blanc	Blanc chaud	3000K	40°	EEK: B
BC 40 A Châssis argent	Blanc chaud	3000K	40°	EEK: B
BN 40 N Châssis noir	Blanc neutre	4000K	40°	EEK: A
BN 40 B Châssis blanc	Blanc neutre	4000K	40°	EEK: A
BN 40 A Châssis argent	Blanc neutre	4000K	40°	EEK: A
BF 40 N Châssis noir	Blanc froid	6000K	40°	EEK: A
BF 40 B Châssis blanc	Blanc froid	6000K	40°	EEK: A
BF 40 A Châssis argent	Blanc froid	6000K	40°	EEK: A

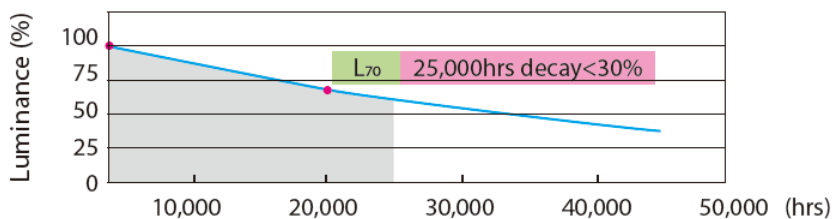
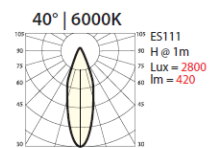
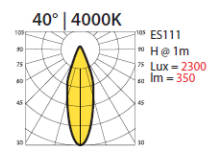
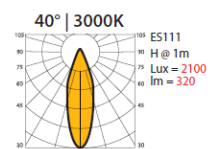

LED Par36 Zoom



12V	AC DC	G5,3
12W	INCLUS 9 LED	ANGLE D' OUVERTURE 10-60°

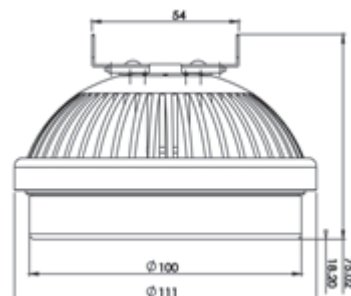

Focus réglable 10-60°

LED PAR36 BF Zo
LED PAR36 BC Zo

Blanc froid 154,00 €HT
Blanc chaud 154,00 €HT



LED Par 38 Zoom



230V	E27	15W
INCLUS 9 LED	ANGLE D' OUVERTURE 10-60°	

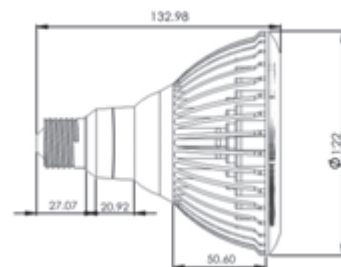

Focus réglable 10-60°

LED PAR38 BF Zo
LED PAR38 BC Zo

Blanc froid 162,00 €HT
Blanc chaud 162,00 €HT



FLUTER LED 10W



FLUTER LED 10 C Blanc Chaud 98,00 €HT
 FLUTER LED 10 F Blanc Froid 98,00 €HT

230V	10x1W	INCLUS LED
INCLUS Transfo	ANGLE D'OUVERTURE 120°	700 lm
IP65	116mm B 92mm H 81,5mm T	0,7 kg

FLUTER LED 30W



FLUTER LED 30 C Blanc chaud 198,00 €HT
 FLUTER LED 30 F Blanc froid 198,00 €HT

230V	30x1W MODUL	INCLUS LED
INCLUS Transfo	ANGLE D'OUVERTURE 120°	2100 lm
IP65	187mm B 227mm H 127mm T	2,6 kg

FLUTER LED 50W



FLUTER LED 50 C Blanc chaud 278,00 €HT
 FLUTER LED 50 F Blanc froid 278,00 €HT

230V	50x1W MODUL	INCLUS LED
INCLUS Transfo	ANGLE D'OUVERTURE 120°	3500 lm
IP65	202mm B 227mm H 127mm T	3,9 kg

FLUTER LED 80W



FLUTER LED 80 C Bland chaud 478,00 €HT
 FLUTER LED 80 F Blanc froid 478,00 €HT

230V	80x1W MODUL	INCLUS LED
INCLUS Transfo	ANGLE D'OUVERTURE 120°	5600 lm
IP65	288mm B 397mm H 120mm T	5,6 kg